

Cubro Packetmaster EX 2

The desktop Network Packet Broker

Functions

Link/Port Aggregation

Aggregation of up to 4 ports or 2 links 10/100/1000 Mbit to 2 x 1/10 Gbit to a single or multiple output ports.

10 Gbit traffic de-multiplexer

If highly loaded 10 Gbit links have to be monitored the traffic can be easily de-multiplexed into 4 low traffic Gbit links.

Jumbo Frame Support

The Packetmaster supports jumbo Ethernet frames with a size of up to 9000 Bytes.

Ports

4 x 10/100/1000 Base-T
2 x SPF+ 1/10 Gbit
1 x 10/100/1000 Base-T (Management)
1 x RS232 Console

Configuration / Communication

WEB GUI
Telnet and SSH Text Menu
Telnet and SSH CLI

Bandwidth

26 Gbps backplane
30 million Packets per/sec

Aggregation latency

average 2 µs for 64-byte frames

MTBF 198,185 hours

Rugged desktop Housing

The Packetmaster is delivered in a ruggedized desktop housing with precise connector labeling on the front panel.

Operating Temperature

0 to 45°C

Operating Humidity

90% maximum relative humidity

Dimension

W=150.00mm, L=100.70mm, H=25.80mm

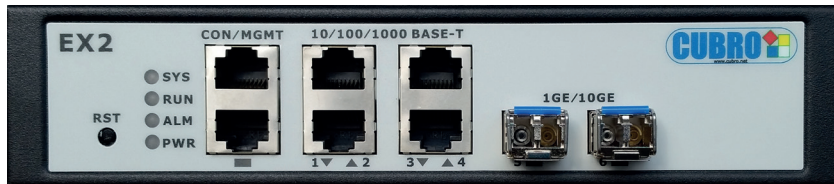

The Packetmaster EX2 is a new development of the existing EX platform based on a fully new designed ASIC. The Packetmaster EX2 supports 4 x 10/100/1000 Mbit and 2 x 1/10 Gbit ports (SFP SFP+) Each of the 10 Gig ports can be loaded with a SFP+ or SFP which can be single mode as well as multi mode. Each port can have an output and/or an input functionality. IPv4 and IPv6 support is included as well.

No additional software costs - all applications included

No additional port fees.

Currently the configuration is done via a CLI, text based menu, a graphical GUI via the cubro control server, or a Java based rich client.

General Functions

Aggregation:

Traffic aggregation from many input ports to one or many output ports.

This works also with different Link speeds, e.g. 10 G input - 1 G output.

Filtering:

Up to 1024 flow rules (filters) can be set in the unit. You can filter on VLAN, MAC, IP, PORT and some more fields found in packets. This filter can work with all other options together.

Available options are: drop, send to output port, modify

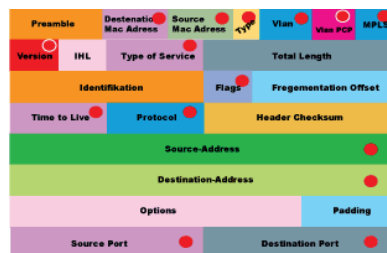

Modify Traffic :

Strip vlan, add vlan, change mpls, change mac

Back with optional installed optical TAP (SM and MM)



The Cubro Packetmaster EX2 is a reliable Packet Processing Engine. Designed for high speed and loss less packet handling.



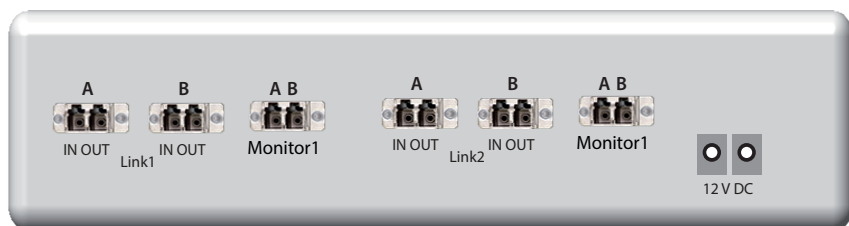
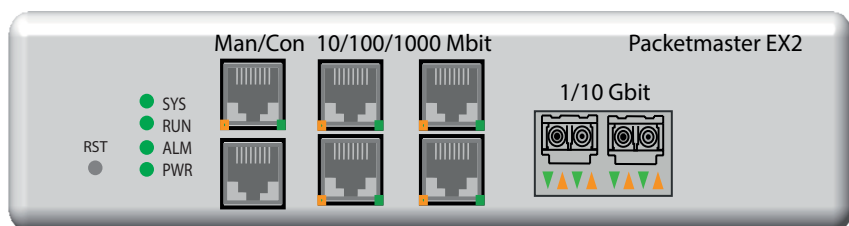

Inputs*

- 4 x 10/100/100 full duplex Base-T
- 2 x 1/10 Gbit full duplex SFP/ SFP+ Ports for any kind of SFP/SFP+
- * Each port can be input or /and output depending on the application and configuration

Outputs*

- 4 x 10/100/100 full duplex Base-T
- 2 x 1/10 Gbit full duplex SFP/ SFP+ Ports for any kind of SFP/SFP+
- * Each port can be input or /and output depending on the application and configuration

Operating Specifications

Operating Temperature: 0°C to 40°C
 Storage Temperature: -10°C to 70°C
 Relative Humidity: 10% min, 95% max, non-condensing

Mechanical Specifications:

Dimension (HxWxD): 150 x 100 x 25 mm
 Weight : 1.2 kg

Electrical Specifications:

Input Power: 12 DC, 2,5 A,

Certifications

Fully RoHS compliant
 CE compliant
 Safety:
 UL 60950-1 / CSA C22.2 60950-1-07 / IEC 60950-1 (2005)
 EN 60950-1 (2006)

Performance

- Performance up to 26 Gbit
- 30 million packets/sec
- non Blocking design
- Boot time from power on to working 180 sec
- Packet delay through processing less than 2 µs

Management

Management Port: (1) RJ45 10/100 Mbit
 Configuration (CLI) Port: (1) RS-232 DB9
 USB

Indicators

- (All ports) Link LEDs
- (All ports) Activity LEDs
- 1 Alarm LED
- 2 Power LEDs
- 1 System LED

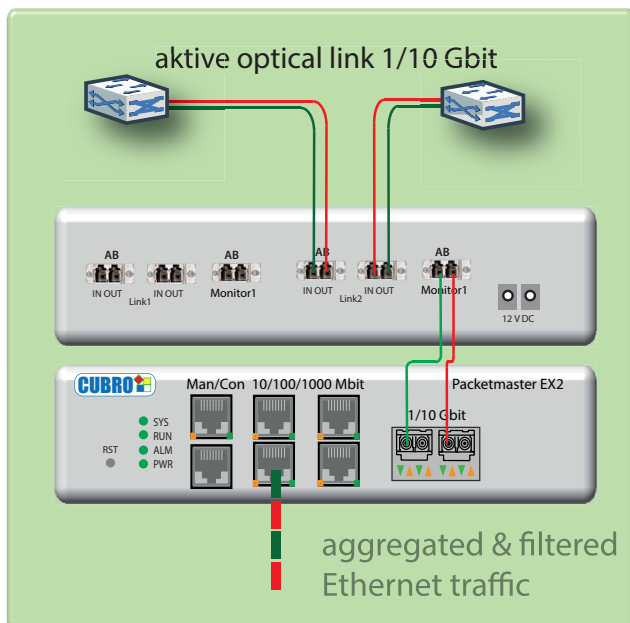

App: 10 Gbit monitoring

The EX2 is connected via the Cubro optical TAP to a 10 Gbit or 1 Gbit optical live link. Using the filtering capability of the Packetmaster EX 2, the user can select only the portion of the traffic which is needed to solve the network problem.

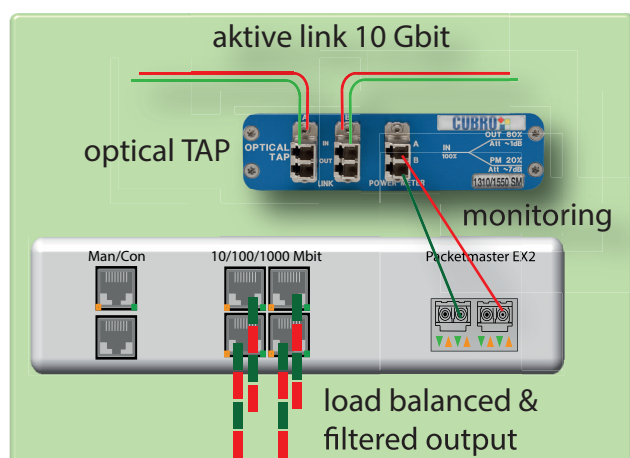

App: 10 Gbit monitoring

The EX2 is connected via the Cubro optical TAP to a 10 Gbit or 1 Gbit optical live link. If it is needed to capture more than 1 Gbit and the capture device has more than one port the EX2 can also load balance the traffic between 4 ports. In this case it is possible to capture 4 Gbit.

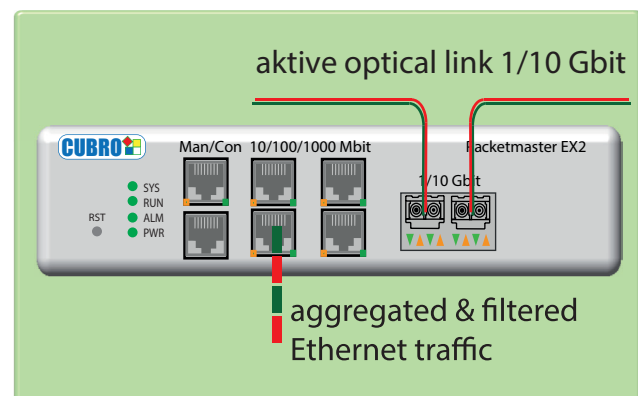

App: 10 Gbit monitoring

The EX2 is connected direct in a live optical link 1 Gbit or 10 Gbit without Tap, and then you can set up filters and send the traffic out on the 4 10/100/1000 Mbit Base-T interfaces. This traffic is small enough to capture it with a standard Laptop.

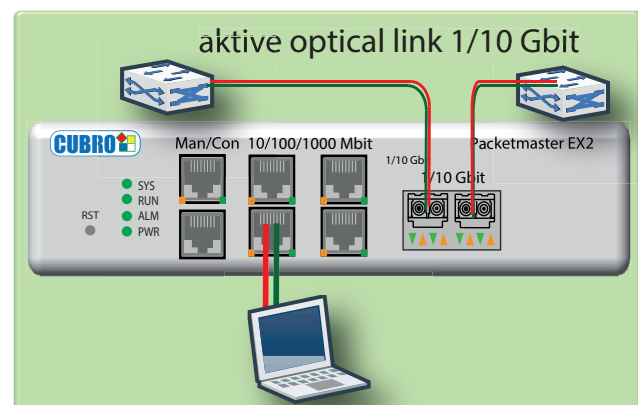

App: 10 Gbit connection

The EX2 is connected directly in a live optical link 1 Gbit or 10 Gbit. Then the EX2 can work as a switch and you connect a PC to this live link.

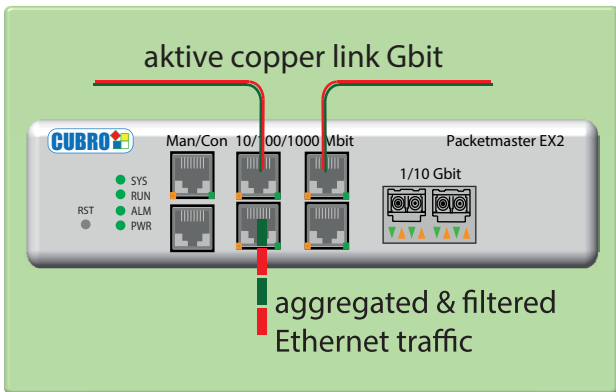

App: 1 Gbit Cooper monitoring

The EX2 is connected directly in a live copper link 10/100/1000 without Tap, and then you can set up filters and send the traffic out on the 4 10/100/1000 Mbit Base-T interfaces. This traffic is than small enough to capture it with a standard Laptop.

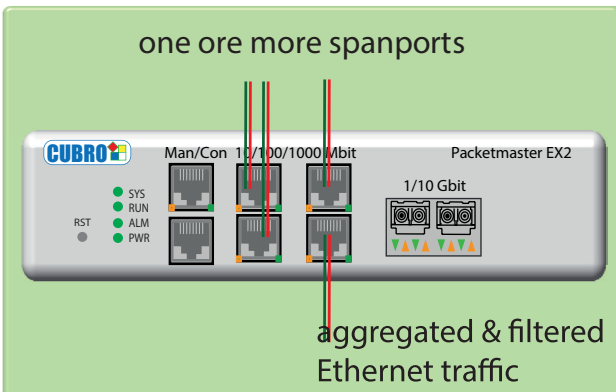

App: 1 Gbit Cooper aggregation

The EX2 could also work as 3 port aggregator and filter device. If you have 3 span port outputs but only on capture port. Then you can use the EX2 for aggregation and filtering.

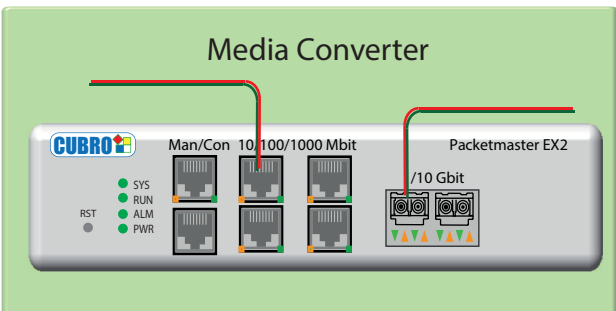

App: Media - Converter

The EX2 can also work as a media converter from

- Copper to Fiber 1 Gbit
- Copper to Fiber 10 Gbit
- Fiber 10 Gbit (SM) to Fiber 10 Gbit (MM)

and much more

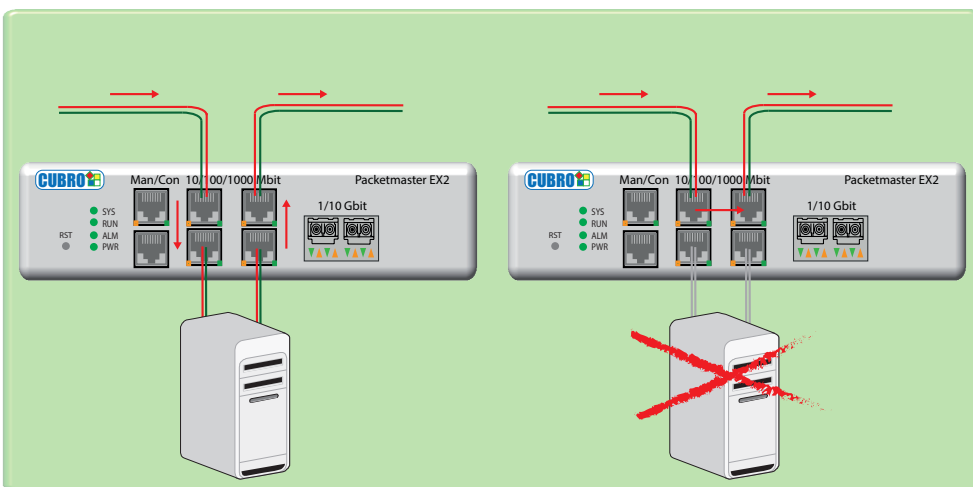

App: Bypass

Packetmaster EX2 as 10/100/1000 bypass with heartbeat. The function that the Packetmaster can produce traffic can be used to build a copper bypass switch with the Packetmaster EX2. This is a very useful application simple flexible and good price relation.

Cubro Packetmaster now with WEB GUI

This GUI is designed to handle the Packetmaster Packet Broker efficient and in an easy way. All major functions are available in the GUI. The idea of this GUI is also to make it easy to troubleshoot the configuration, less click easy and straight forward. Compatibly from IE Version 8 up. No Java, no Flash, good Support for Tablets and Mobil Phones

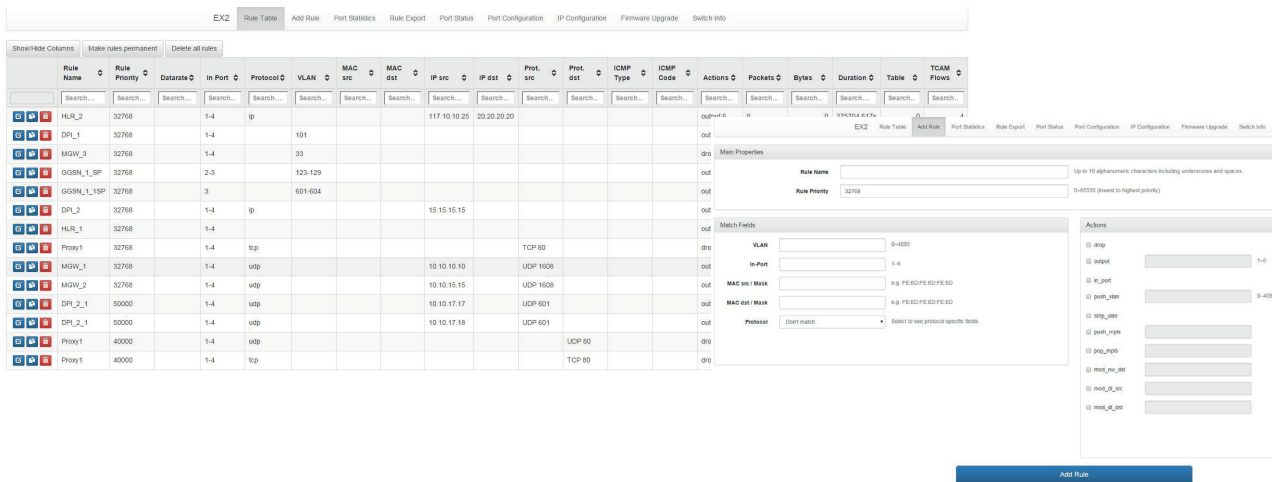

Cubro Packetmaster text based GUI over Telnet or SSH

If it is not possible to connect the Packetmaster via WEB, because of security ore bandwidth constraint. The Text Menu is a good alternative to operate the EX2 in a fast and efficient way.

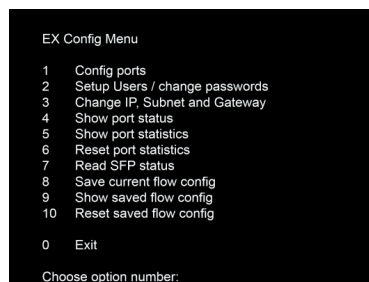

Cubro Packetmaster CLI and Scripting

The Packetmaster EX2 is also supporting a standard CLI, this CLI can be used in interactive mode or can be integrated in scripts. The OS of the EX2 is supporting Bash and Python as script language.

```
def createFlowFromValueMap(valueMap):
    flow = {}
    flow["cookie"] = ""
    flow["table"] = ""
    flow["match"] = {}
    flow["actions"] = ["drop"]

    _addToMapIfNotEmpty(flow, valueMap, "priority")
    _addToMapIfNotEmpty(flow, valueMap, "cookie")
    _addToMapIfNotEmpty(flow, valueMap, "table")
    if ("in_port" in valueMap and (not valueMap["in_port"]=="")) and (not valueMap["in_port"]==None)):
        flow["match"]["in_port"] = _parse_int_ranges(valueMap["in_port"],1,DEVICE_PORTS)
    if ("d1_vlan" in valueMap and (not valueMap["d1_vlan"]=="")) and (not valueMap["d1_vlan"]==None)):
        flow["match"]["d1_vlan"] = _parse_int_ranges(valueMap["d1_vlan"],0,4095)
    _addToMapIfNotEmpty(flow["match"], valueMap, "d1_src")
    _addToMapIfNotEmpty(flow["match"], valueMap, "d1_dst")
    if ("protocol" in valueMap and (not valueMap["protocol"]=="")) and (not valueMap["protocol"]==None)):
        if (valueMap["protocol"] == "custom"):
            _addToMapIfNotEmpty(flow["match"], valueMap, "d1_type")
            _addToMapIfNotEmpty(flow["match"], valueMap, "nw_proto")
        elif (valueMap["protocol"] == "mp15"):
            flow["match"]["d1_type"] = "0x8847"
        else:
            flow["match"][valueMap["protocol"]] = ""
            _addToMapIfNotEmpty(flow["match"], valueMap, "nw_src")
            _addToMapIfNotEmpty(flow["match"], valueMap, "nw_dst")

    if (valueMap["protocol"] == "tcp"):
        _addToMapIfNotEmpty(flow["match"], valueMap, "tcp_src")
        _addToMapIfNotEmpty(flow["match"], valueMap, "tcp_dst")
    elif (valueMap["protocol"] == "udp"):
        _addToMapIfNotEmpty(flow["match"], valueMap, "udp_src")
        _addToMapIfNotEmpty(flow["match"], valueMap, "udp_dst")
    elif (valueMap["protocol"] == "icmp"):
        _addToMapIfNotEmpty(flow["match"], valueMap, "icmp_type")
        _addToMapIfNotEmpty(flow["match"], valueMap, "icmp_code")
    elif (valueMap["protocol"] == "sctp"):
        _addToMapIfNotEmpty(flow["match"], valueMap, "sctp_src")
        _addToMapIfNotEmpty(flow["match"], valueMap, "sctp_dst")

    if ("actions" in valueMap and (not valueMap["actions"]=="") and (not valueMap["actions"]==None)):
        valueMap["actions"] = valueMap["actions"].replace("output:", "").split(",")
        flow["actions"] = ""

    outputs = [_parse_int_ranges(x,1,DEVICE_PORTS) for x in valueMap["actions"] if re.match("^[0-9]+-[0-9]+$",x)]
    for i in range(0,len(outputs)):
        outputs[i] = [str(x) for x in outputs[i]]
    outputs[i] = " ".join(outputs[i])
    actions = [x for x in valueMap["actions"] if not re.match("^[0-9]+-[0-9]+$",x)]

    actions+= outputs

    flow["actions"] = actions

return flow
```



Packetmaster EX2

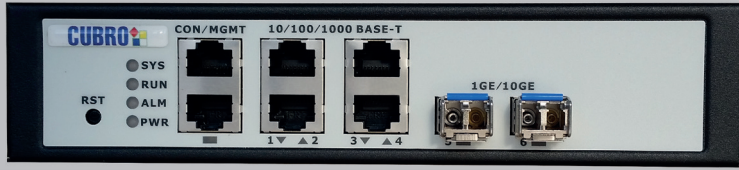

CUB.PM-EX2

List of components

Packetmaster EX2
AC/DC powersupply
European powercord
(no SFP)

Packetmaster EX2+



CUB.PM-EX2+

List of components

Packetmaster EX2
AC/DC powersupply
European powercord

built in singlemode TAP 80/20
built in multimode TAP 50/50

transport case

(no SFP)

Packetmaster accessories



PC.USB-GB-KONV



PC.WLAN-BRIDGE